

MOROCCAN VASES | MOROCCAN VASE 5 LARGE - SUSPENDED | MOROCCAN-5-LRG-S



DESCRIPTION

A collection of medium sized pendant lamps inspired by the forms of and colours of Moroccan metal vases. This version is the most elaborate and is illuminated by a G9 Halogen or G9 3W LED lamp within a Pyrex glass ball. Alternatively E27 LEDs can also be specified.

PRODUCT SIZE

SHADE SIZE: 405W X 555H MM / TOTAL HEIGHT: 1065MM

PACKAGING DIMENSIONS

610MM(W) X 610MM(L) X 330MM(H)



LAMP TYPE & NO

1 X G9-HALOGEN 18-40 WATT LAMPS (40W) OR 1X G9-2.5W LEDS OR 1 X E12/14 // E26/27 LED

CLASS II
IP RATING 54
QC RATING 21

VOLTAGE RANGE
110 - 240 V

PRODUCT MARKS & RATINGS



WEIGHT 2.6KG
PACKED WEIGHT 7.6KG

TECHNICAL DRAWING

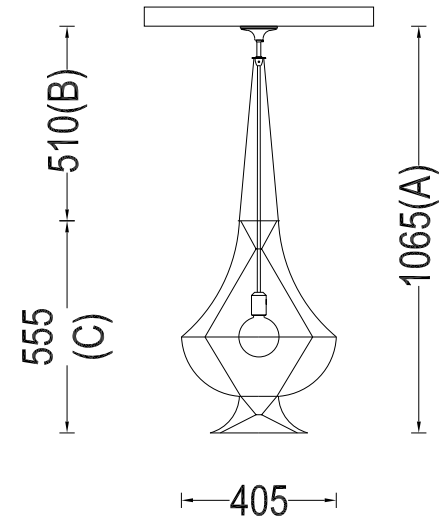

INTERACT

SELECT COLOUR

- SILVER *
- BRASS *
- COPPER *
- SMOKE *
- MIXED METALIC *
- RUST *
- WHITE
- RED
- BLACK

* METALLIC

CUSTOMISE DIMENSIONS

A

B

LAMP TYPE

QUANTITY

ADDITIONAL COMMENTS

[WEB LINK](#)

[DOWNLOAD](#)